



## Series 35i-MODEL B

Fast, flexible and reliable



FANUC America Corporation  
[www.fanucamerica.com](http://www.fanucamerica.com)  
888-FANUC-US (888-326-8287)



# Series 35i-MODEL B – First choice for transfer machines and general motion applications

The Series 35i-MODEL B has been developed for high performance specialized machine tool and general motion applications. The Series 35i is an integrated solution providing a variety of powerful custom screen development tools, a high-speed multi-path PMC ladder interface, up to 16 axes/4 paths of high-performance motion control and 4 spindles. The Series 35i is the first choice for transfer machines, simple machines and a wide range of general motion applications. FANUC controls have a world-class reputation for performance, precision, reliability and user-friendly operation. With more than 2.4 million controls and 12.7 million servo motors installed around the globe, FANUC is the world's leading CNC, motion system and robot manufacturer.



# The first choice for the most demanding applications

The Series 35i-MODEL B is designed for today's high performance transfer machines and motion applications. Comprehensive machining and drilling features, combined with up to four programmable paths, allow the Series 35i-B to be versatile in modular applications from one to four machining stations. For flexible general motion control, the rate feed mode command allows easy programming of custom motion profiles. Up to five integrated PMC ladders manage machine functions, station sequencing and interfacing to peripheral devices without the need for separate PLC hardware. The Series 35i-MODEL B is ideal for your next transfer machine or general motion project.

- Ideal for one or multiple stations in high-performance transfer machines providing powerful customization and easy integration into a larger process.
- Efficient for a wide range of simple machines from washers to welding stations providing an operator interface, axis motion, multi-ladder interface and easy integration with auxiliary equipment in a single package.
- Suitable for a wide range of general motion applications with easily programmed multi-axes/multi-path control.
- Ideal for servo applications that replace electro-mechanical or hydraulic controls, providing energy efficient dynamic power source regeneration and low-loss power-stage devices.
- A broad range of highly customizable display solutions are available to meet application needs including integrated LCD screens, standalone solutions supporting multiple screens and sophisticated hand-held displays that are ideal for teaching or operations close to the application.
- Integrates seamlessly and quickly into production systems with the widest range of field network support. Communications with business systems, manufacturing systems and robots achieved easily with Ethernet and Ethernet/IP.
- Integrated safety is available to meet specific industry or application requirements.

## Linear

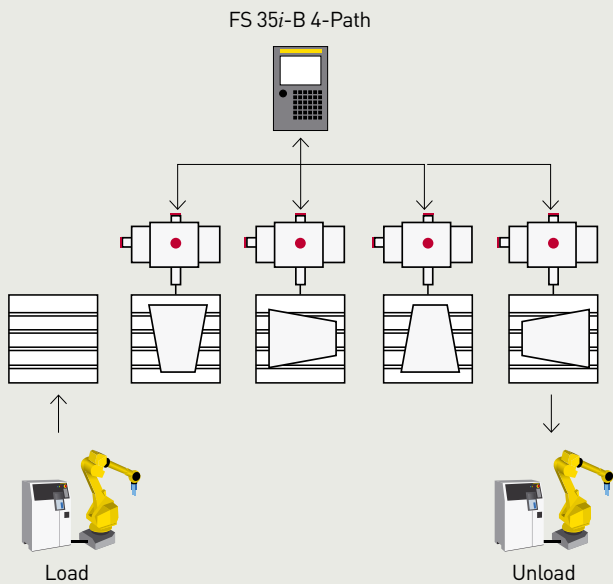

## Rotary

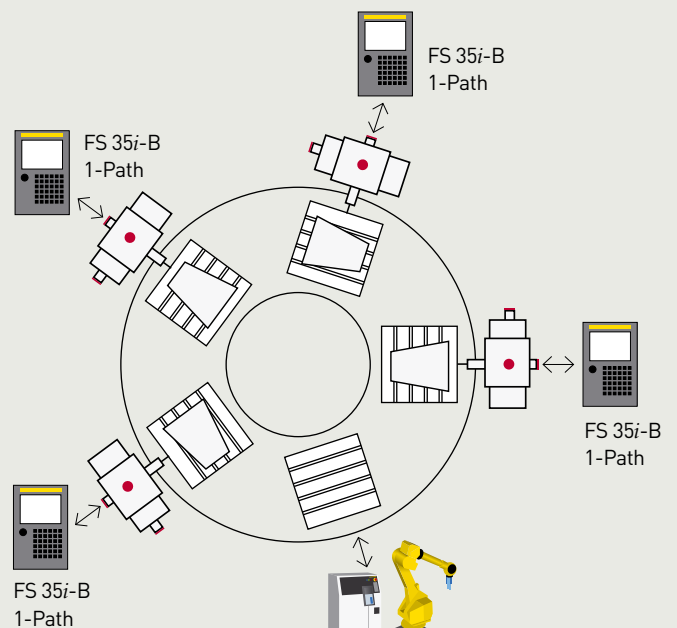

# Efficient drilling, tapping & basic machining

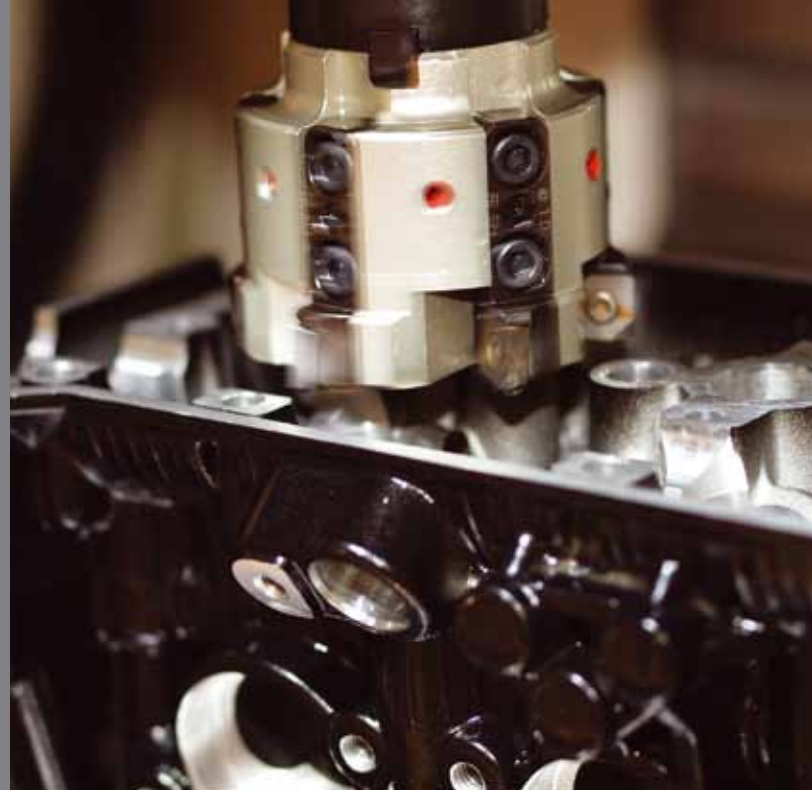

The features in the 35i-B CNC are tailored to the type of operations used in transfer line applications for high performance and high-efficiency machining.

- Linear & circular interpolation
- Helical interpolation
- Polar coordinate interpolation
- Mirror image
- Coordinate system rotation
- Tool length and tool radius compensation
- Work piece coordinates – 48 pairs
- Advanced preview control
- Canned cycles for drilling – small hole peck drilling
- High speed and torque limit skip
- Backlash, smooth backlash compensations
- Pitch, absolute pitch and straightness compensations

High speed FSSB communications between the 35i-B and FANUC digital servo and spindle amplifiers achieves high accuracy rigid tapping at high speeds.

- High-speed rigid tapping using advanced feed forward
- Optimum torque acceleration/deceleration for rigid tap

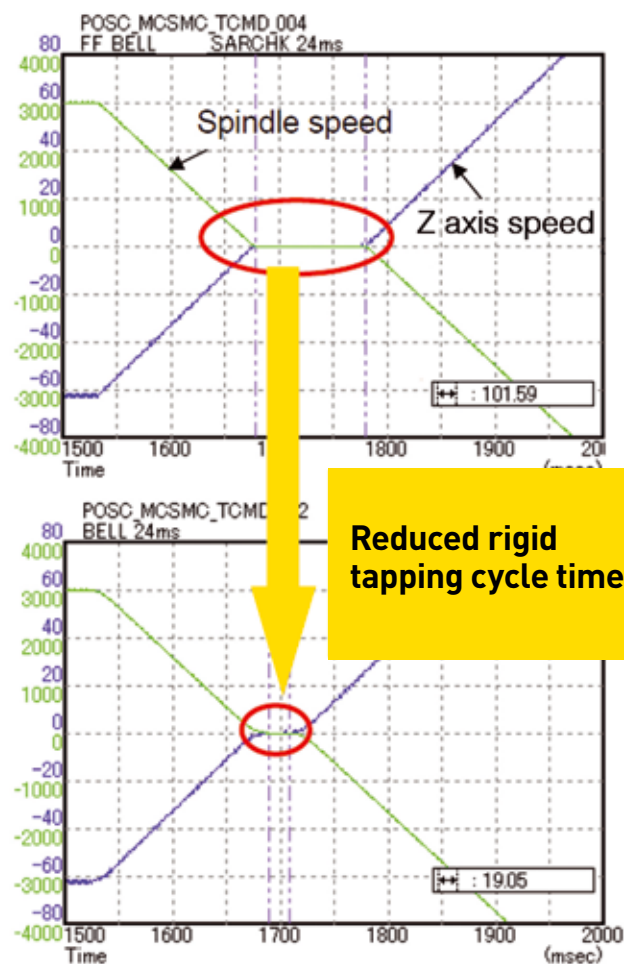



# Reducing cycle time

## In-position check switching function for drilling canned cycle

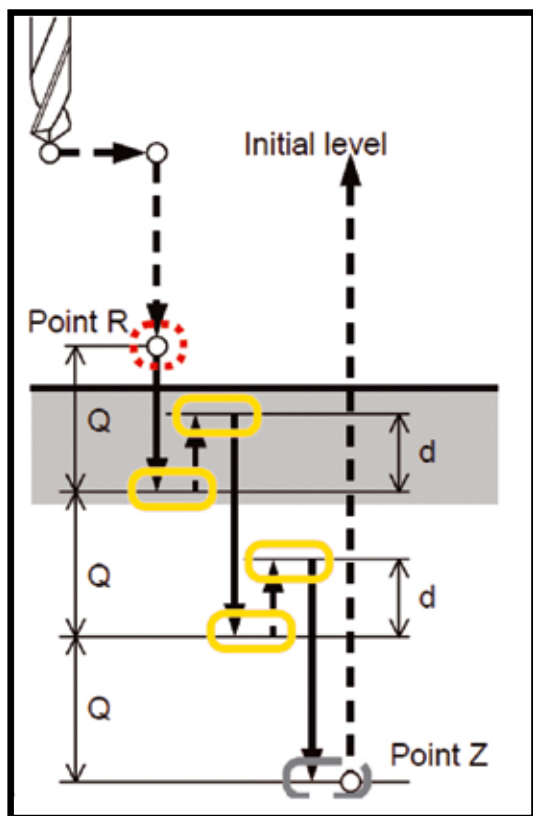
Traditionally, the same in-position zone setting is used for all motions in a drilling canned cycle. The tight in-position time required for accuracy at the bottom of a hole is excessive for the less critical entry and pecking motions, wasting time. In-Position Check Switching provides up to four in-position widths to be set separately. By expanding in-position zones when less accuracy is acceptable, cycle times can be reduced.



-  Normal In-Position
-  Peck Drilling In-Position
-  Bottom of Hole In-Position

# Powerful feed rate control

For general motion applications, powerful feed rate functions simplify motion profile programming.

## Rate feed command for general motion control

For flexible general motion control, the rate feed mode command allows easy programming of custom motion profiles. The axis smoothly accelerates or decelerates from the current feed rate to the new feed rate specified over the distance moved. The feed rate values can be specified in mm/min or in/min. The rate feed command is modal; once issued, it remains active until changed.

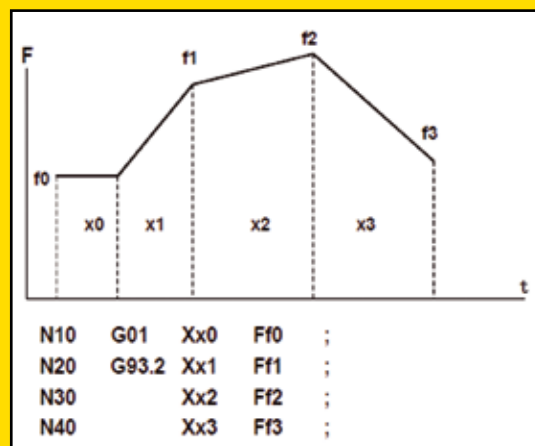

## Feed rate change function

Feed rate during linear and skip moves can be overridden or set to one of 8 values set based on external signal input. Feed rate settings are defined by parameters.

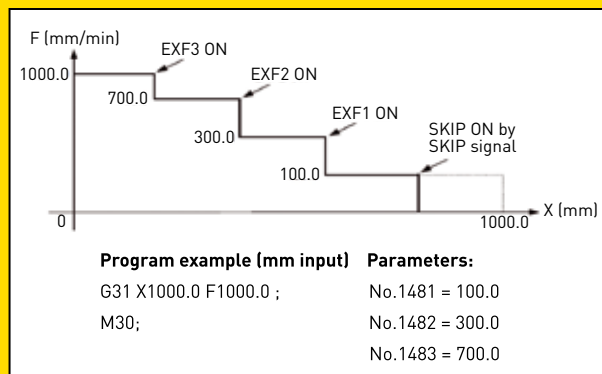



# A totally integrated motion system



## Single source responsibility

The Series 35i is a highly integrated system with displays, high-speed, multi-path PMC ladders, multi-axes motion control including motors and drives manufactured and completely supported by FANUC to give you peace-of-mind for application development and long-term product support.

## Efficient integration

Using integrated hardware minimizes wiring and mounting of electrical components. A fiber optic connection between the control and the servo drives provides guaranteed noise immune data exchange at distances up to 300 feet. A similar fiber optic connection is utilized between the control and the display. I/O Link *i* provides a fast serial interface between the PMC and I/O devices, and provides up to 2,048 devices per channel. Digital technology throughout ensures that any data transfer can be performed at high-speed and error-free.

## Flexible OI development

The Series 35i supports a wide range of operation interface displays. The application software includes multiple screens ready to run any application. Integrated or external LCD displays are easily customized with FANUC PICTURE. PC-based operator interfaces are available to support Windows-based application development.

## Simplified motion application

In contrast to a PLC-based motion solution, there is very little motion application development. The control of multiple axes or motion are commanded within a simple text-based program. The integrated program editor is simple yet powerful. If the application demands, groups of axes can be programmed independently in paths, with synchronization points between the paths as required.

## Drive systems

For optimum application performance, FANUC offers a totally integrated range of drives and motors, from traditional rotary and linear servo motors through to very large servo motors. Simple maintenance, high-quality, compact design, exceptional power and efficiency are key factors inherent in their design. General motion applications benefit from FANUC's experience and production volume in machine tool applications - ensuring the highest quality at affordability.

## Integrated PMC/PLC

An integrated, ultra-fast PMC processor controls and monitors the rapid and smooth operation of all machine auxiliary devices. The PMC sequence control offers execution speeds of 9.1 nanoseconds per step for ladder logic programs, and up to five ladders can be executed at the same time.

# Integrating with external systems

The Series 35i-MODEL B supports a wide range of popular field networks and it's an easy interface between CNC and robots. Most devices can be connected with a single cable using high-speed, intelligent protocols, reducing integration time and cost.

## Robot interface

A standard interface between a FANUC robot and a machine tool significantly reduces both integration time and cost. Integrating the Series 35i-MODEL B with a FANUC robot for automated loading/unloading is simplified by use of the robot connection function interface. This function allows robot operation and monitoring from the 35i-B display screens, without entering the robot safety fence. Manual jogging of robot axes by coordinate system or joint method along with homing of robot can be

executed from the machine operator panel - without the use of the robot teach pendant. Peripheral actions such as gripper or vacuum operation can also be displayed for manual operation. Robot programs can be selected for use from the menu display, or selected in combination with the 35i-B program for combined machining and robot operation.

## Open communication

As well as FANUC's own integrated I/O structure, alternative fieldbus systems (Ethernet/IP, DeviceNet, Profibus-DP, AS-i, I/O Link II, FL-net, Modbus/TCP and CC-Link) may be connected.

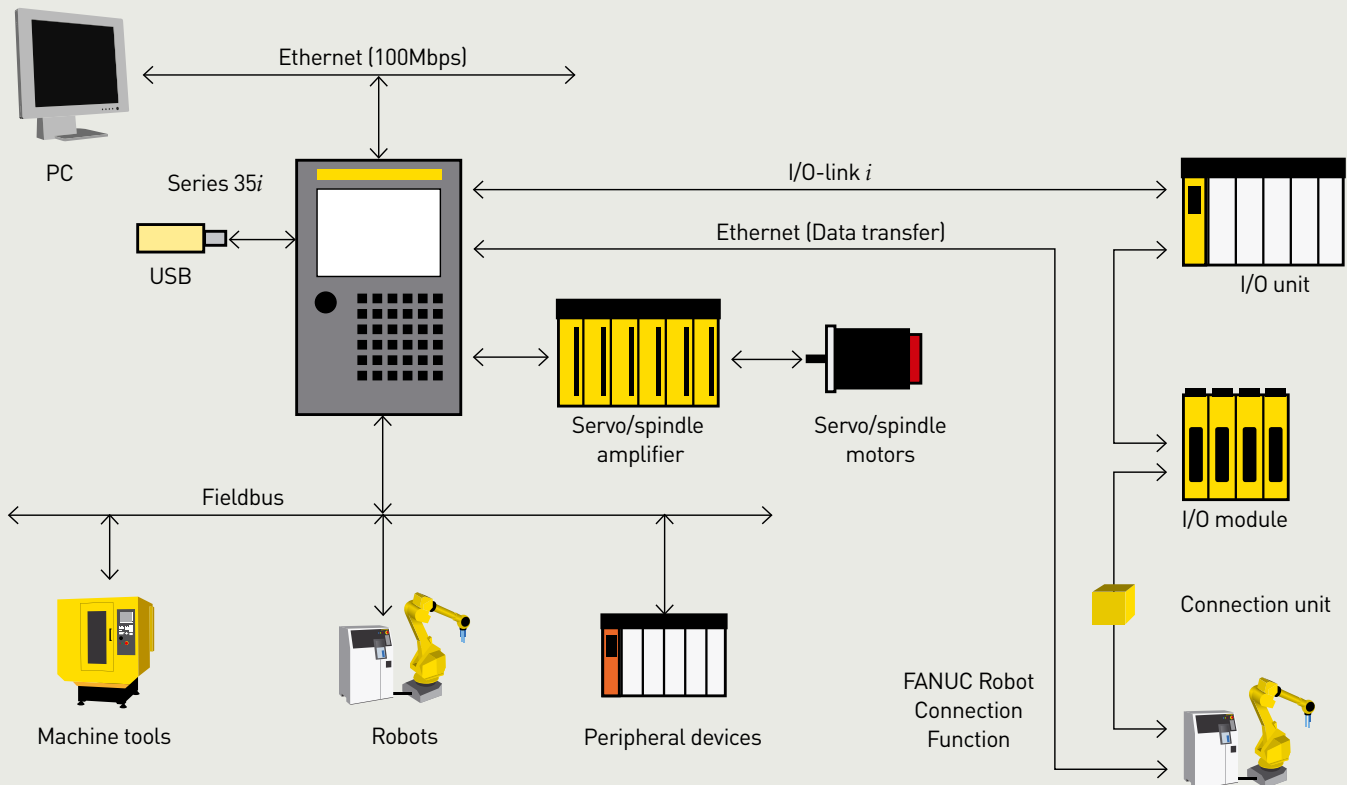

# Connecting manufacturing and business

Today's ultra-competitive business environment demands flexibility and speed from every aspect of the company. Business speed and customer satisfaction relies on instant access to information that is only possible by connecting manufacturing to business systems, securely and reliably.

The Series 35i-MODEL B meets the challenge with a high-speed Ethernet interface. It supports the industry standard File Transfer Protocol (FTP) for high-speed file transfers. Screens guide the operator to download or upload files to any FTP server directory on a network. The FOCAS2 interface provides robust, documented access to practically unlimited motion control, machine and process data. Using Drivers and Libraries, applications can be developed quickly with standard industry development tools.

## High-speed file transfers

The Series 35i-MODEL B supports the industry standard File Transfer Protocol (FTP) for high-speed transfers of part programs, parameters, tool data and other files. CNC screens guide the operator to download or upload files to any FTP server directory on a network.

## Powerful data collection

The FOCAS2 interface provides robust, documented access to practically unlimited CNCs, machine and process data. Using Drivers and Libraries, applications can be developed quickly to provide information such as current status, part counts for each part program, active error messages and tool offset values. Read and write routines are provided to a wide range of CNC and PMC data elements - allowing powerful systems integration.

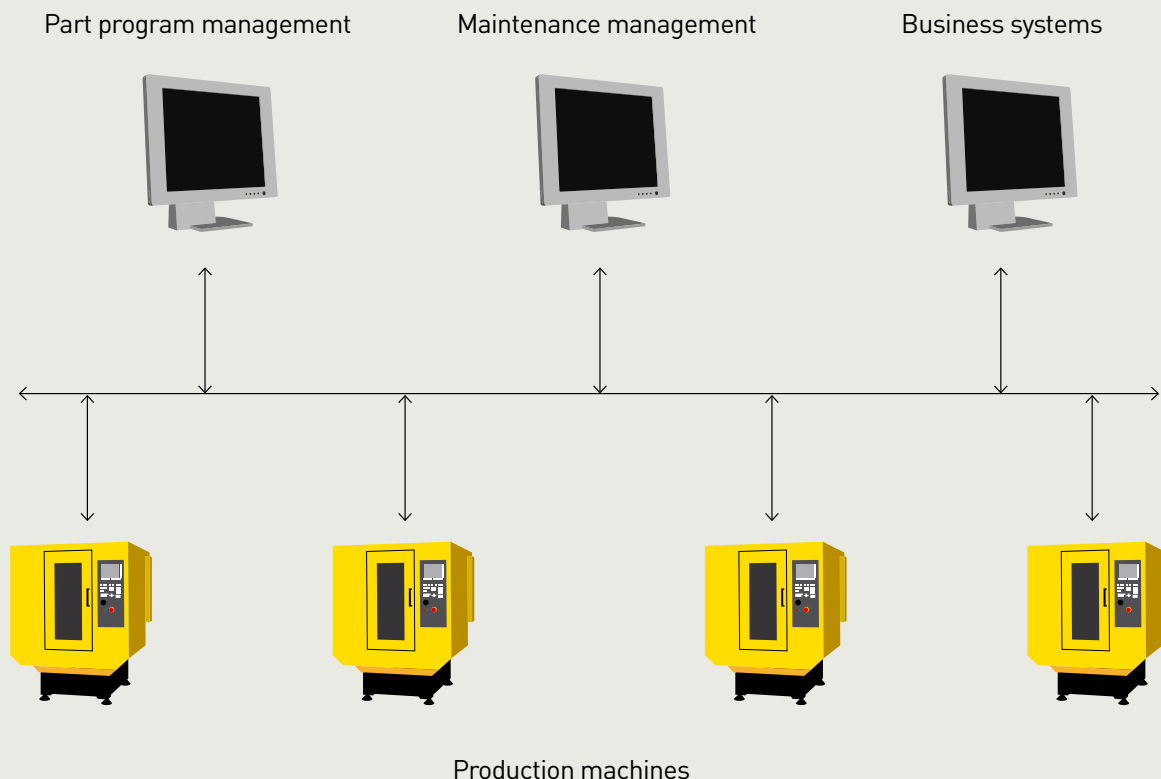



## High-speed Ethernet

The standard 100-MBit Ethernet interface integrates the CNC into a network for high-speed part program transfers and the collection of process related data. It also supports remote troubleshooting from the maintenance department or a machine tool builder anywhere around the world. Because the Ethernet port does not use a public operating system, it is practically “hacker-free” and virus immune.

The Fast Ethernet option board provides a dedicated CPU to support multiple connections and is suitable for DNC operation and remote operation using CNC Screen Display function.

## Communications software

To communicate between the Ethernet port on the CNC and a PC, software is required.

- The Part Program Transfer Tool provides a simple drag-n-drop interface to transfer files between a PC and the CNC.
- Fast Ethernet software function adds displays to the CNC that can interact with a remote FTP server so that the operator can request file transfers from a specified directory on the network. Up to 3 locations on the server can be pre-defined for operator convenience.
- CNC Status Notification function delivers CNC alarm and parts count status email messages to a PC or portable device, such as a tablet or smart phone. This makes machine status notification available to you remotely anytime, anywhere.

## Part program management

The Series 35i-MODEL B provides up to 1MB of nonvolatile internal memory for part program storage. External card slot is provided for an additional 2GB of part program storage using economic ATA or Compact Flash memory cards.

Part programs stored in external memory cards can be edited and executed just like internal memory, providing practically unlimited capacity.



## USB Port

A USB port is also conveniently located at the operator display to provide practically unlimited storage for transfer of part programs, tool data and parameters using a wide range of commercially available USB flash drives. Files can be easily moved between office, computers and the machine tool - quickly loading part programs into internal CNC memory for execution.

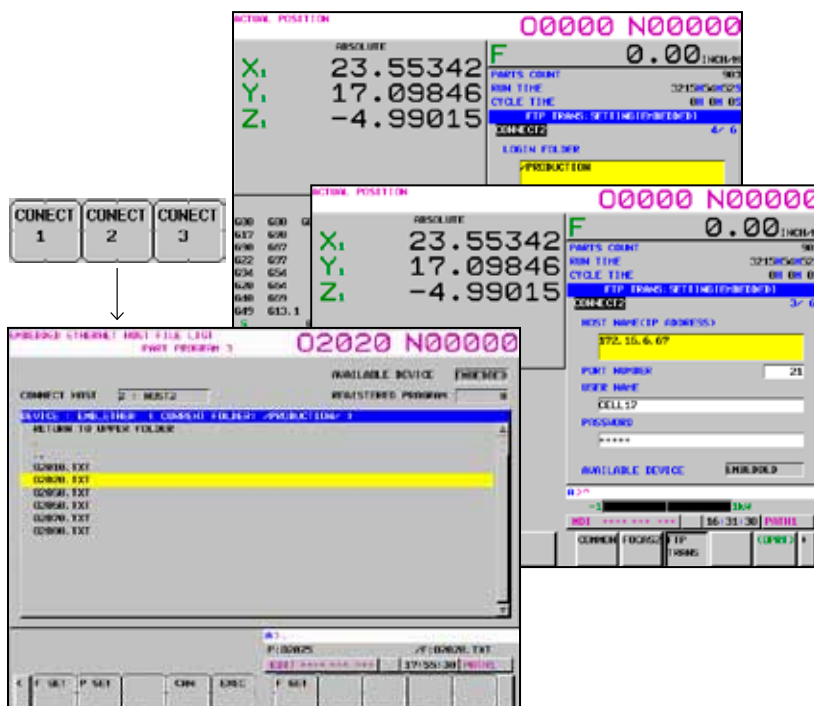

# Flexible operator interface development

The Series 35i-MODEL B has easy yet powerful tools for screen development, providing machine tool builders and integrators the flexibility to configure the operator interface to meet their requirements and to add proprietary functionality.

FANUC PICTURE simplifies custom screen development through the use of predefined icons for display components and operator selection buttons. Additionally, advanced functionality can be added with the powerful C-Language-Executer. Custom screens can complement the standard factory screens. Macros using M and G-codes can also be created, providing motion cycles that can be executed at the push of a button. The Automotive HMI provides reliable, high-performance hardware, a rugged touch-screen and standardized screen templates so that a common operator interface look-and-feel can be delivered in FANUC PICTURE or Windows, regardless of the application or manufacturer.

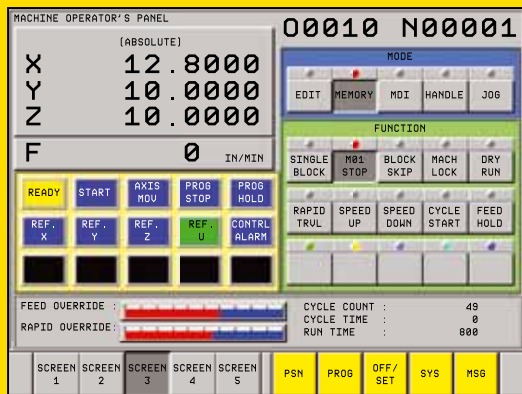

FANUC PICTURE

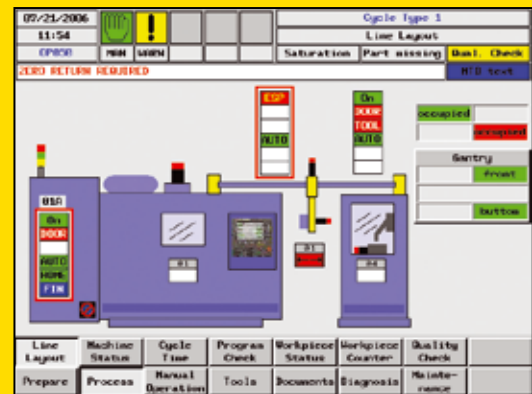

Automotive HMI



C-Executer



## PC-integration

At FANUC, the designation 'Open' refers to the combination of a dedicated motion controller and a PC via Ethernet or a high-speed fiber optic interface, which allows transfer of large amounts of data.

### The Series 35i-MODEL B has two 'open' versions:

- Windows® Embedded Standard 2009 for compatibility to Windows® XP Professional 32-bit applications
- Windows® Embedded Standard 7 for compatibility to Windows® 7 Professional 64-bit applications

Both models support the FOCAS2 protocol for the high-speed exchange of data between the motion controller and the PC.

FANUC's Open architecture enables the integration of 3rd-party applications. Open permits the development of a wide variety of applications such as custom graphical user interfaces (GUIs) for specialized applications and the exchange of large volumes of data via networks.

## iPendant

The FANUC *iPendant* is a factory hardened, portable display and operation panel that can be highly customized.

It has multiple applications with Series 35i-MODEL B:

- Complement the primary display on large machines to allow the operator and workstation to get close to the workpiece
- Used as the primary display when the application has simple, temporary or portable display requirements

The FANUC *iPendant* supports all the standard Series 35i screens for operation, programming and maintenance. A touch panel interface is available. Customizing of machine operation keys is available with the use of the transparent key sheet.

Keyboard function can be switched between MDI (manual data input) mode for data entry and editing, or machine operation mode which enables the keys to be used for manual axis motion, operation of miscellaneous functions and automatic machine operation. Use of machine operation mode is executed by the machine's PMC interface for functionality and safety by the machine tool builder. *iPendant* also can be equipped with a small MPG (manual pulse generator) device for manual axis operation by Handle Mode. A USB port for file I/O is located on the rear of the unit.

The *iPendant* interfaces to the motion control unit through a built-in or detachable connection unit. A built-in unit is used for permanent operation, while a detachable unit allows the *iPendant* to be easily removed for portability or security.





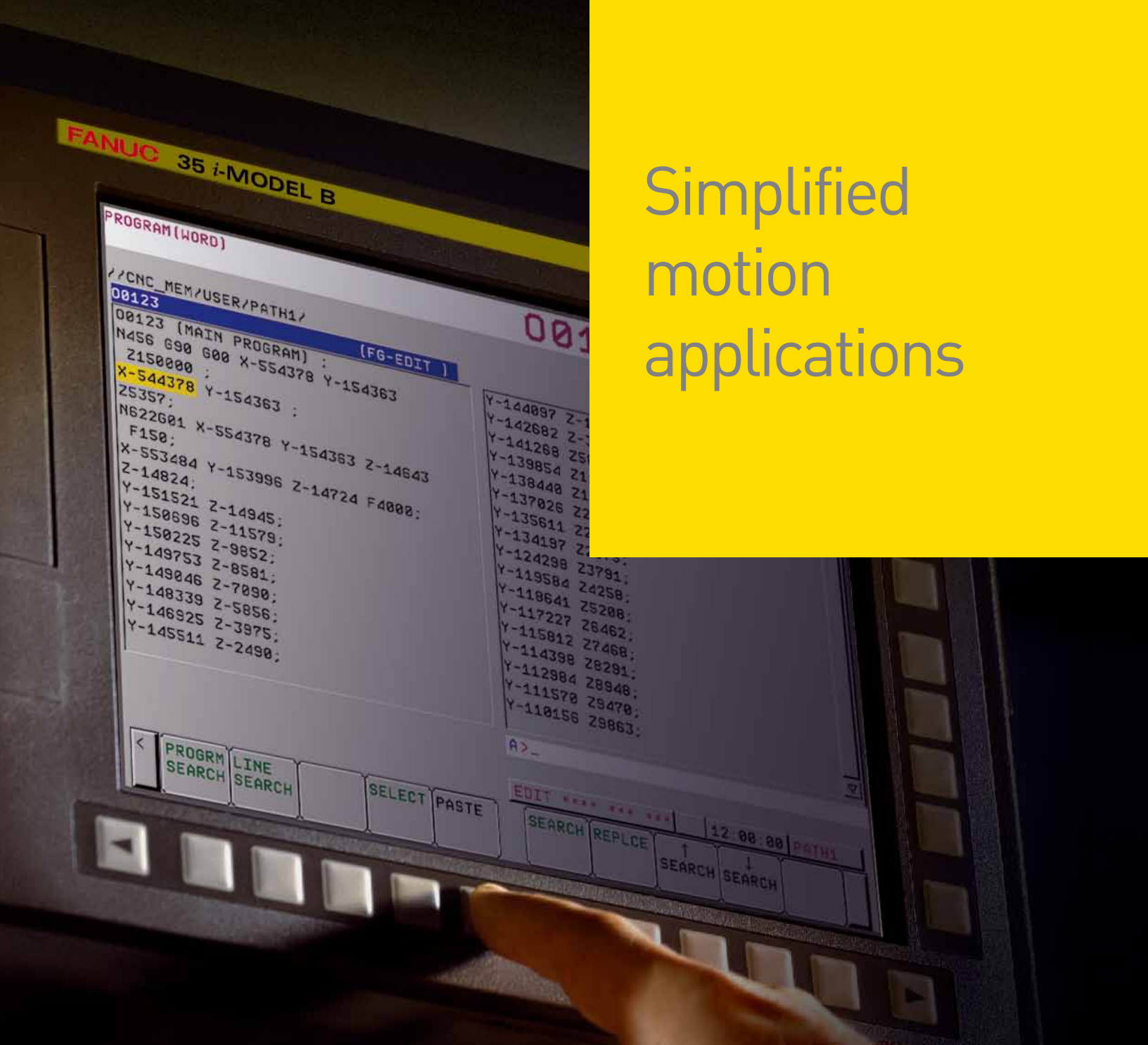

# Simplified motion applications

## Easy yet powerful motion programming

The Series 35*i* is primarily a motion control system. That means the basic system is designed to simplify controlling a large number of axes without any application development. The movement of the axes or groups of axes can be controlled synchronously with interpolation or asynchronously with M-codes.

A simple industry standard letter-address text file is created to command the motion of the axis. Multiple text files can be

created for flexible applications. The Custom Macro feature provides flexibility adding variables and program flow control to the basic programming.

For industries that use CNC based machine tools, operators that already have experience with FANUC controls will be comfortable with the Series 35*i*-MODEL B in no time at all, without the need for expensive retraining.

## Powerful motion program editor

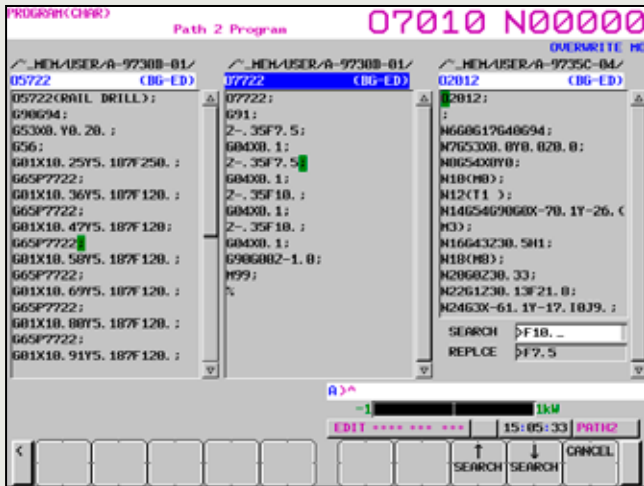

Program and operational consistency is a cornerstone of FANUC's commitment to interoperability. The traditional word editor mode is fully supported and enhanced, whereas the flexible character editing mode may satisfy the needs of a new generation of operators that are used to PC-editors. Character editing mode also makes it easier to quickly modify complex word structures such as Custom Macro statements and program comments.

The background editor allows multiple programs to be displayed side-by-side on the screen and provides the same powerful cut-and-paste and search-and-replace operations as the foreground editor. Background editing mode also allows one part program to be downloaded and modified while another part program is executing in the foreground. Multi-path part programs can also be displayed side-by-side.

## Custom Macro

Custom Macro extends the standard motion programming language to include the features of an easy-to-use, yet powerful computer programming language. Typical uses include interfacing of external devices such as touch probes or creation of flexible, custom motion cycles using passed arguments. Compiling or development tools are not required.

- Variables - local variables to the immediate call or instance, common variables for sharing of data globally, and system variables providing motion controller data continuously from the motion controller are easily used within the program. Variables may be saved for backup and reuse.
- Operations including arithmetic and logical operators, flow control and conditional branching provides for versatile logic in easily understandable format.
- Macro calls - simple use or modal, including passing of arguments may be nested to 5 levels. Subprogram calls to 15 levels deep.

## Prevention of operational errors

Unintentional mistakes can be reduced by requiring operators to confirm things such as deleting motion programs and re-starting motion programs in the middle of a cycle. Limits can be placed on the values entered in a variety of setting screens to prevent crashes due to simple data entry errors.

## Virtual MDI panel

The virtual MDI panel is ideal for very high production (automotive) or general motion applications with very little data entry or editing at the machine. Virtual MDI display is used with touch LCD Display. The normal MDI keyboard is replaced by virtual keyboard on the display screen optimizing panel space. The virtual keyboard uses touch screen when MDI functions are needed.

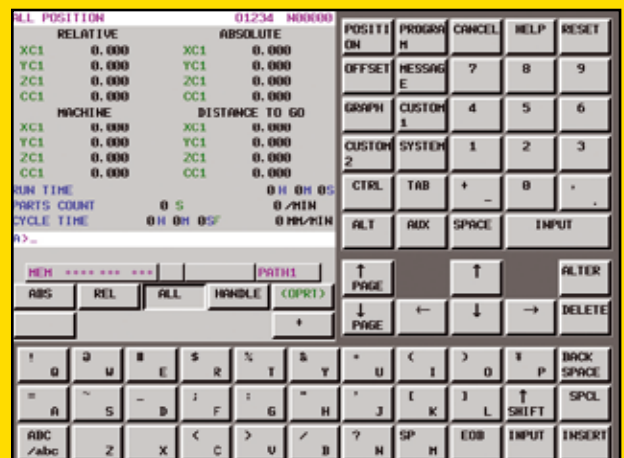

# Simply the best drives available

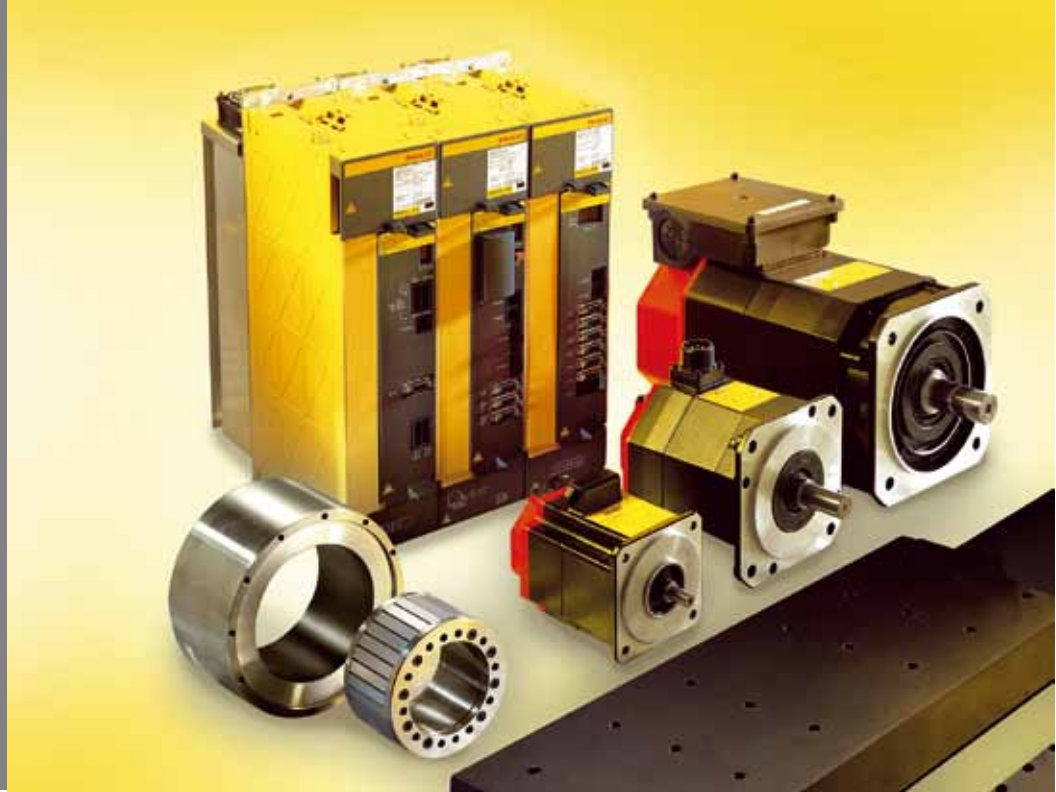

## FANUC AC servo & spindle motors

FANUC AC servo & spindle motors provide ultra-smooth rotation and quick acceleration.

- Wide range of servo motors with stall torques between 0.16Nm to 3,000Nm ensures there is a motor for practically any application
- AC spindle motors in flange or foot type mounting configurations from 0.55KW – 200KW and speeds up to 20,000 RPM, with built-in spindle motors up to 70,000 rpm
- Compact size is achieved with an optimized internal structure delivering the smallest motors minimizing machine size
- Intelligent servo motors store all the characteristics of the motor and pulse coder for quick application and replacement



### Servo motors

*ai* series AC Servo Motor

*Bi* series AC Servo Motor

*LiS* series Linear Motor

*DiS* series Synchronous Built-in Servo Motor

### Spindle motors

*ai* series AC Spindle Motor

*Bi* series AC Spindle Motor

*Bi* series Built-in Spindle Motor



## FANUC linear motors

FANUC linear motors provide the ultimate in high-speed, high-precision positioning.

- Wide range of motors with stall torques between 300Nm to 17,000Nm ensures there is a motor for practically any application
- High-speed, high acceleration achieve a maximum speed of over 150-inches per second and an acceleration of over 30G, which is difficult to achieve with conventional servo motors
- High-accuracy is achieved using a cooling structure to minimize heat transfer from the motor to the machine

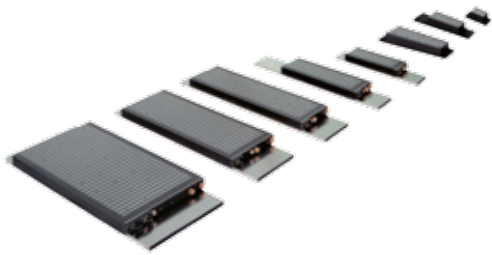

## FANUC servo drives

FANUC servo amplifiers connect to the control system over high-reliability, noise immune fiber optic cables.

- **Compact size:** Optimized cooling design results in smaller amplifiers and electrical cabinet requirements
- **Energy saving:** Power consumption is reduced significantly with power source regeneration and the use of low power loss devices
- **Leakage detection function:** The *ai* servo amplifiers for the 35i-B series contain a leakage detection function which can detect degradation of motor or power line insulation, without an additional module.
- **Technologies for large output:** Larger motors can be applied by using multiple standard amplifiers or tandem control for multiple motors driving a single axis



## Energy saving servo systems

The servo motors in a motion system are continuously accelerating and decelerating as they change speed and direction. When motors are decelerating, their kinetic energy is converted back into electrical energy, which must be dissipated. Low cost drive systems simply burn the energy as heat in a resistive load in a process called dynamic braking.

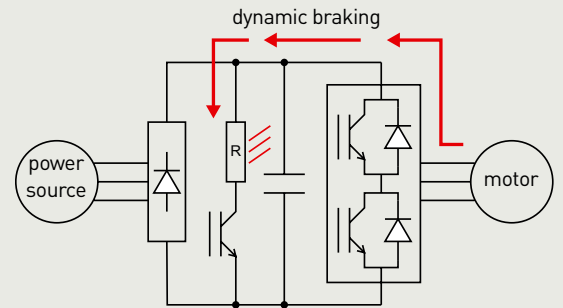

FANUC's state-of-the-art AC drive systems use high-speed, high-efficiency switching circuits to direct the energy back into the main electrical supply, reducing the net energy used. When combined with the more efficient motion processes provided by the Series 35i-MODEL B, electricity costs can be reduced significantly.

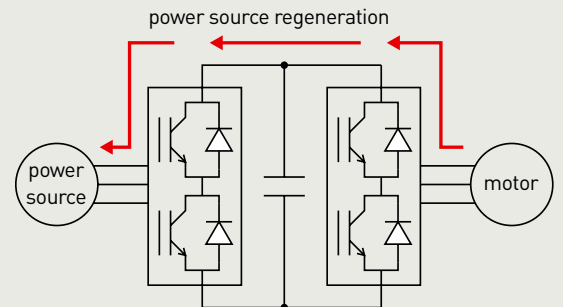

FANUC's motion control systems provide displays that monitor real-time energy usage and savings and allow the data to be collected via Ethernet for analysis. For example, use data to optimize part cycle time versus power consumption.

POWER CONSUMPTION MONITORING			
INSTANTANEOUS VALUE OF POWER			
	-50	0	50 (kW)
X	[Progress bar]		10.095
Y	[Progress bar]		-3.841
Z	[Progress bar]		15.120
B	[Progress bar]		4.798
C	[Progress bar]		-1.309
	-100	0	100 (kW)
S1	[Progress bar]		44.239



# Integrated safety

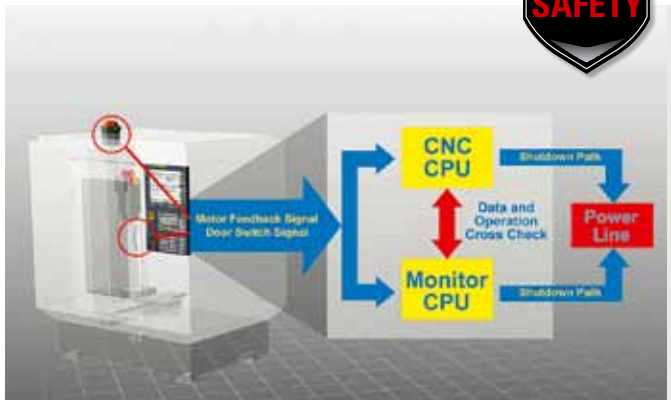

## Safety I/O unit

The safety I/O unit is a single module interface that provides redundant inputs and output safety signals when Dual Check Safety is used, requiring only a single I/O Link *i* channel.



## Integrated safety

Many machine tools today must comply with safety category Performance Level D (EN/ISO 13849-1). With Dual Check Safety, the Series 35i-MODEL B supports an integrated safety function that complies with European safety standards over a single cable.

Using built-in redundancy, a special processor for monitoring safety-related parameters guarantees the safety of the system by following the actual position and speed of the servomotors, spindle motors and the I/O interfaces. One advantage of this software solution is that less space is required in the electrical cabinet as the mechanical components required by traditional solutions are no longer needed.

### Dual Check Safety, basic functions:

- Safety brake monitoring
- Safe spindle speed (4 ranges)
- Safe servo axis speed (4 ranges, velocity & positioning)
- Safe machine axis position (4 ranges)
- Safe stop
- Safe I/O's
- Safety I/O signal history function
- Safety spindle speed limit override function
- Test mode function for acceptance test

### Safety I/O

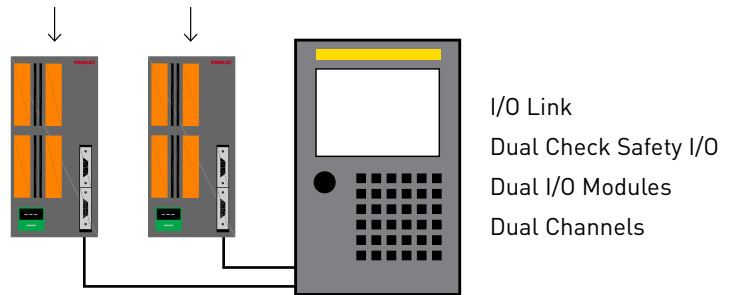

### Safety I/O

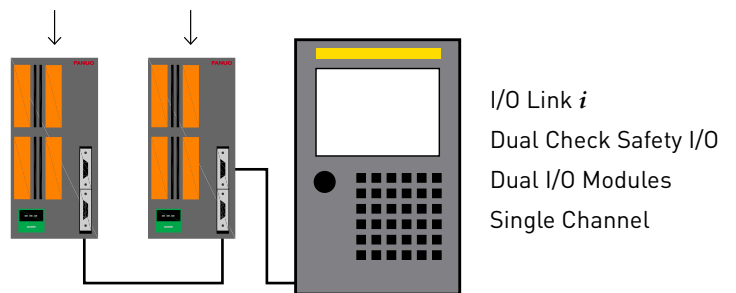

### Safety I/O unit

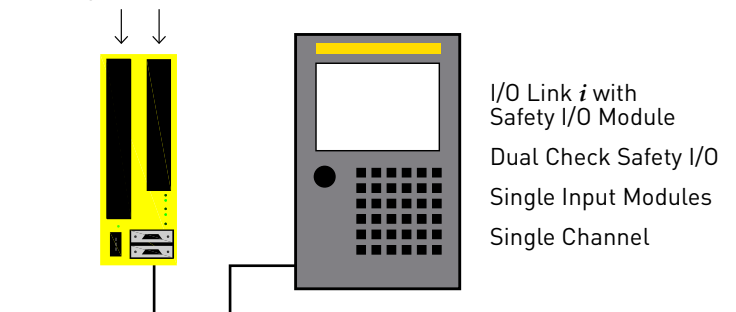

# Extreme reliability - maintenance friendly



## Unmatched reliability

Downtime on your manufacturing system is very expensive, especially when you add up the cost of repairs, the lost production capacity, and the potential revenue and goodwill lost if you miss customers' deliveries. FANUC's continuous improvement culture ensures that our motion systems are the most reliable available. Statistically, a hardware fault occurs only once for every 17 years of productive service.

With a 25-year replacement part availability and support commitment\*, convenient local parts inventories and economical repair and return services, you can look forward to decades of trouble-free operation with the confidence that your general motion application will be available for production when you need it.

## Simple All Data Backup for maintenance

All Data Backup function carries on from the previous All I/O function by automatically outputting all backup files available in text format to USB or CF memory card. Maintenance personnel do not have to select individual files by soft key for backup, only one key is used for a simple 2-step backup process. SRAM image and FROM based user files such as PMC ladder, FANUC PICTURE or Macro/C-Exec files are also saved. All Data Backup should be included as part of a preventative maintenance schedule to insure a total backup of the control is available.

\*When a FANUC CNC system is out of production, we strive to have replacement parts for 25 years. Replacement parts are available for purchase or through extended service contracts. If and when parts are no longer available due to discontinued component manufacturing, we offer repair and reuse. We strive to engineer replacement parts with the same functionality, form and fit. We offer on-site FANUC factory-trained service and support on FANUC CNCs for the lifetime of your machine.

## Periodic maintenance screens

Motion control and machine component life can be tracked according to a schedules such as power on time and axis moving time. When the actual usage exceed the scheduled maintenance period, the operator is alerted.

## Troubleshooting guidance

Screens lead maintenance technicians easily through recommended procedures to identify the root cause of problems. Integrators can add their own guidance screens.

## Free over the phone support

Factory-trained CNC service engineers provide fast response time and free unlimited phone support during regular business hours. Support during normal business hours of 8:30am - 5:00pm Monday through Friday will be provided by your local service center. By calling 888-FANUC-US, your call will be automatically routed to your local service center or the next available engineer.

Because problems don't always happen during regular business hours Monday through Friday, CS24 CNC after-hours phone service is also available, for a nominal fee, to protect your weekend and 2nd/3rd shifts productivity and bottom line.

## Maintenance friendly

Batteries and fans are modularized for quick and easy replacement without tools. Fan monitor screen allows quick and easy view of control and motor amplifier fan operation. A comprehensive package of maintenance tools is integrated into the Series 35i to help keep your application running and making production. A snapshot of any screen can be captured to a memory card to be used in troubleshooting.

## Alarm and operation history

To assist in troubleshooting, a history of keys pressed, PMC signals and alarms are recorded automatically and can be displayed. When an alarm occurs, additional data such as model information and axis position data may also be recorded and displayed.

## Built-in automatic backup

The Series 35i helps you recover quickly from unforeseen data loss by maintaining an automatic backup of part programs and critical SRAM data. Up to three independent backups can be scheduled by parameter setting.

## Automatic servo and spindle tuning

Recommended servo and spindle servo tuning parameters can be determined quickly and automatically by simply pressing a softkey on a screen built into the CNC, eliminating the need for costly specialized resources. Servo Guide Mate is a built-in function that provides graphical interpretations of servo and spindle servo system performance that can be used to optimize the machine. The graphical data can be saved for later comparison during machine maintenance.

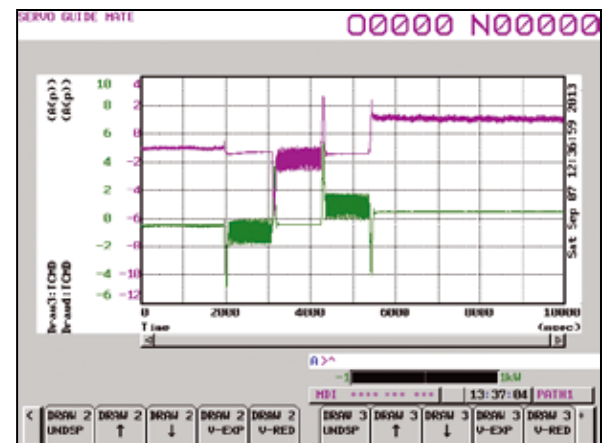
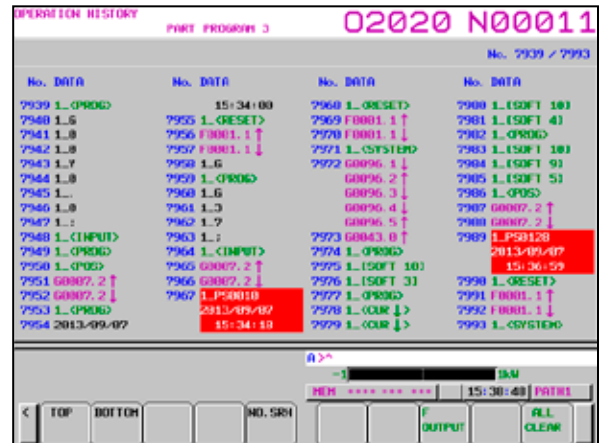
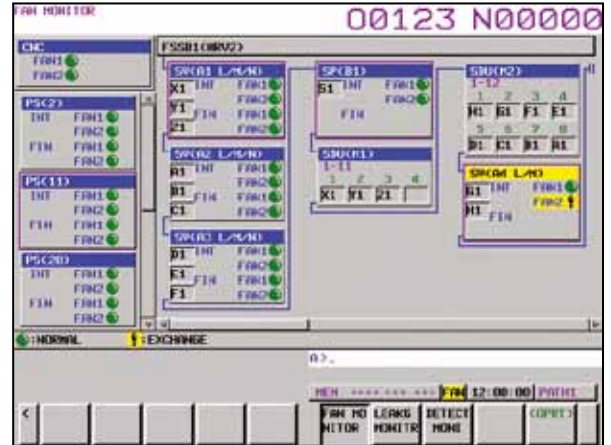



# NCGuidePro for Series 35i-MODEL B

NCGuidePro is FANUC's CNC software running on a PC, providing a powerful development and realistic operation and part programming environment at a fraction of the cost of using a hardware simulator or a production machine tool. Development is more efficient in an economically friendly environment - away from the noise of the manufacturing floor. Engineers can develop, test and debug applications without risks to people, tooling or machines.

## Powerful development environment

NCGuidePro is ideal for application development supporting all the major CNC systems.

- PMC ladder execution and debug
- FANUC Picture, C-executor, Macro Executor and Automotive HMI operator interface screens
- Part program edit and execution
- Custom Macro programming and debug
- FOCAS2 development
- FANUC or custom operator panels and sub-panels are supported
- SPECIAL MDI key supports special functions including next path, loader path and background editor selection

## Superior PMC ladder development

NCGuidePro and FANUC LADDER-III may be executed on the same computer or two separate computers for ladder development, test and debug.

The I/O operation panel provides simple switches and lights and the machine simulator provides a special ladder to be incorporated to simulate machine inputs and outputs for enhanced ladder testing and debug.

## Superior FANUC PICTURE development

NCGuidePro and the FANUC PICTURE development tools may also be executed on the same computer or two separate computers for screen development, test and debug.





# 10 unbeatable arguments for controls from FANUC:

1. Maximize machine uptime and minimize TCO with FANUC's world class reliability, delivering MTBF rates in excess of 17 years.
2. Secure investment with a 25-year replacement part availability and support commitment.\*
3. Increase competitive edge with state-of-the-art technologies to increase quality, efficiency, reliability and to reduce cycle times.
4. Minimize training and support costs with continuity of operation and upward compatibility to run existing programs on new motion controls.
5. Reduce delivery times with quick and easy at-the-machine programming.
6. Increase daily production time with a motion system that is 'ready-to-go' in less than 30 seconds.
7. Boost efficiency with Ethernet enabled data and remote diagnostics.
8. Minimize downtime by separating motion control and PC technologies.
9. Rely on a world class partner for simple through complex motion applications.
10. Simplify integration with FANUC robots by using the standard interface.

## FANUC 25-year replacement part availability and support commitment\*

\*When a FANUC CNC system is out of production, we strive to have replacement parts for 25 years. Replacement parts are available for purchase or through extended service contracts. If and when parts are no longer available due to discontinued component manufacturing, we offer repair and reuse. We strive to engineer replacement parts with the same functionality, form and fit. We offer on-site FANUC factory-trained service and support on FANUC CNCs for the lifetime of your machine.



## Series 35i- MODEL B

Maximum number of controlled axes	20
Maximum number of feed-axes	16
Maximum number of spindle-axes	4
Maximum number of simultaneously interpolated axes	4
Maximum number of controlled program paths	4
Maximum axis controlled by PMC	16
Maximum part program storage	1 MB
Increment System A 0.01 mm, 0.01 degrees, 0.001 inches	•
Increment System B 0.001 mm, 0.001 degrees, 0.0001 inches	•
Increment System C 0.0001 mm, 0.0001 degrees, 0.00001 inches	•2
PMC system	•
Maximum PMC paths (simultaneous program processing)	5
Maximum number of PMC program steps	300,000
PMC processing, ns per basic instruction step	9.1
PMC Execution Cycles	8, 4, 2, 1 msec
Ladder Dividing Management Function	•
Maximum number of I/O points	4096/4096
PMC axis control	•1, •2 (up to 16 groups)
Torque Control (included in PMC Axis Control)	•1, •2
Maximum tool offsets	200
Maximum workpiece coordinate offsets	48
Stand-Alone mount logic rack with 2 expansion slots	•
LCD mount logic rack with 0, 1 or 2 expansion slots	•
Open System	☆
Integrated safety 'Dual Check Safety'	☆
Dual Check Safety Acceptance Test Function	☆
Data communication	RS-232, Ethernet
CNC Status Notification Function	☆
Field Communication	FL-Net, Safety by FL-Net, DeviceNet, Profibus, CC-Link, Ethernet IP Scanner/Adapter, Modbus-TCP
<b>Standard display</b>	
TFT-LCD color display	8.4", 10.4", 15" LCD
TFT-LCD color display with Touch Panel	10.4", 15" LCD
PCMCIA ports accessible from front bezel	•
USB port for Data I/O accessible from front bezel	•
<b>Display with Windows®</b>	
Processor	Intel® Core™ 2 Duo, Intel® Celeron®
Main Memory	Up to 4GB
Storage capacity	Minimum 500GB HDD or up to a 64GB SSD
Operating system	Windows Embedded OS supplied by FANUC (Windows 7 Professional Supported)
<b>SATA ports</b>	3 Total (1 for SSD card and 2 for general device)
TFT-LCD Color Display	10.4" (800x600), 15" (1024x768) 19" (1280 x 1024)
Keyboard	PC QWERTY or Standard MDI
PCMCIA port accessible from front side	1
USB ports	5 total – 1 front, 4 rear
Serial ports	2
PCI slots	2 (PCI v2.3, 32 bit)
Ethernet port (10BASE-T/100BASE-T/1000BASE-T)	1
iPendant handheld LCD display & panel	☆
Handy Machine Operator Panel	☆
Custom Macro	•1, •2
Addition of Custom Macro Common Variables	•1, •2
Interruption Type Custom Macro	☆
Custom Macro Variables Between Paths	☆
Macro Executor	☆
C-language Executor	☆
FANUC Picture	☆

- Basic Feature
- 1 Included in Basic Option 1
- 2 Included in Basic Option 2
- ☆ Optional Feature

## Series 35i- MODEL B

### Displays

Status/program/parameter	•
PMC monitoring and editing	•
Servo and spindle device	•
Alarm/operating archive	•
Support for up to 19 languages with dynamic language switching	☆
Customer-specific configuration	☆
Screen hard copy	•
<b>Axis Name Expansion (3 char. max.)</b>	•
<b>Control Axis Detach</b>	•2
<b>Inch/Metric Conversion</b>	•2
<b>Manual Handle Feed 1-Unit</b>	•1, •2
<b>Tool Offsets 99 Pairs</b>	•2
<b>Manual Handle Feed 2/3 Units</b>	☆
<b>Tool Offsets 200 Pairs</b>	☆
<b>Tool Offset Memory B or C</b>	☆
<b>Stored Stroke Check</b>	•
<b>Stroke Limit External Setting</b>	•2
<b>Stored Pitch Error Compensation</b>	•2
<b>Stored Pitch Comp Total Value Input</b>	☆
<b>Straightness Compensation</b>	☆
<b>Nano Interpolation</b>	•
<b>Linear interpolation/circular interpolation</b>	•
<b>Dwell (seconds)</b>	•
<b>Helical interpolation</b>	☆
<b>Canned Cycles for Drilling</b>	☆
<b>Small Hole Peck Drilling</b>	☆
<b>Coordinate System Rotation</b>	☆
<b>Polar coordinate interpolation</b>	☆
<b>Advanced preview control</b>	☆
<b>Advanced Feed Forward Control</b>	•
<b>Automatic Acceleration/Deceleration Rapid:Linear Feed:Exponential/Linear</b>	•
<b>Rapid Traverse Bell-Shaped Acceleration/Deceleration</b>	•
<b>Positioning by Optimum Acceleration</b>	☆
<b>Bell-Shaped Acc/Dec after cutting feed interpolation</b>	☆
<b>Axis synchronous control (up to 3 pairs, includes Tandem Control)</b>	☆
<b>Synchronous Cutting</b>	•2
<b>Skip</b>	•
<b>Torque Skip</b>	•
<b>Multi-Step Skip</b>	•2
<b>High Speed Skip function</b>	☆
<b>Position Switch</b>	•2
<b>High Speed Position Switch</b>	☆
<b>Function of Deceleration Stop in case of Power Failure</b>	•
<b>Linear scale I/F with absolute address reference mark (includes distance coded scales)</b>	☆
<b>Unexpected Disturbance Torque Detect</b>	☆
<b>Tool length offsets</b>	•
<b>Tool radius compensation</b>	☆
<b>Constant surface speed</b>	☆
<b>Spindle orient</b>	☆
<b>Spindle Synchronous Control</b>	☆
<b>Rigid tapping</b>	☆
<b>Bell shaped ACC/DEC for rigid tap</b>	☆
<b>Optimum ACC/DEC for rigid tap</b>	☆
<b>High speed rigid tapping</b>	☆ (End 2013)
<b>Spindle control with servo motor</b>	☆
<b>Virtual MDI keys</b>	☆
<b>Wrong Operation Prevention</b>	•

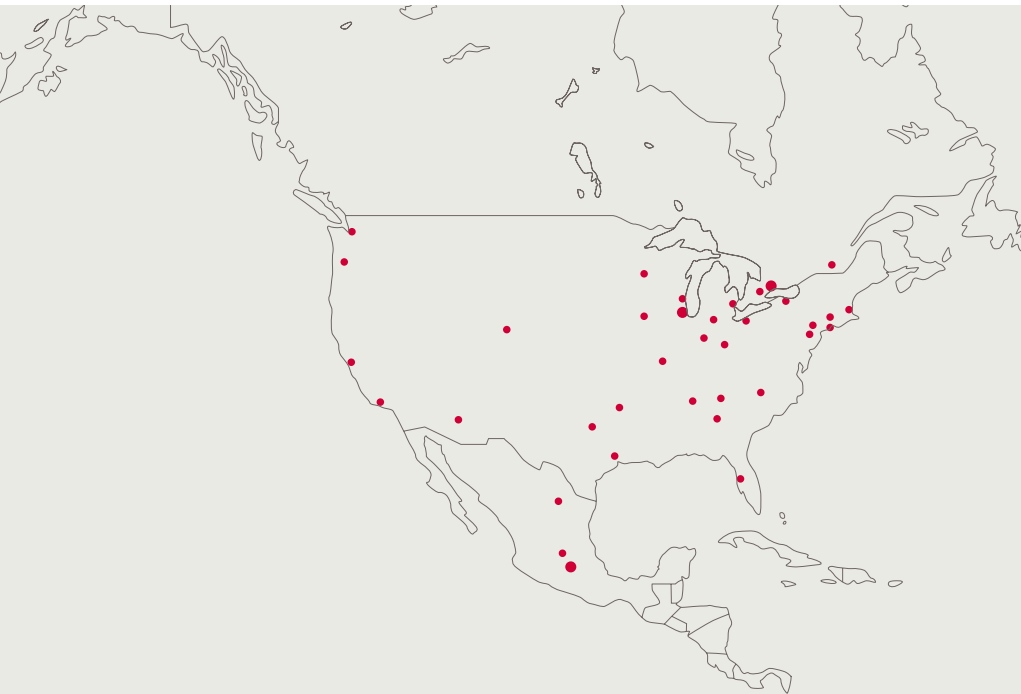

#### FANUC America Corporation

1800 Lakewood Boulevard  
Hoffman Estates, IL 60192  
Tel: 888-FANUC-US (888-326-8287)  
Fax: 847-898-5001  
cnc.info@fanucamerica.com

#### Canada

6774-A Financial Dr.  
Mississauga, ON L5N 7J6  
Tel: 888-326-8287  
Fax: 905-812-0053

#### Mexico

Av. Gustavo Baz # 2160 Edificio 4 PB  
Col. Fracc. Ind. La Loma  
Tlalepantla, Mexico  
Tel: 52 555-010-3400  
Fax: 52 555-010-3410

#### Brazil

Av. Professor Celestino Bourroul 414  
São Paulo, SP 02710-000, Brazil  
Tel: 55 11-3952-8888  
Fax: 55 11-3856-0848

#### Argentina

Av. Juan de Garay 2275/2283  
C1256AAE Buenos Aires, Argentina  
Tel: 54 11-4942-8504  
Fax: 54 11-4942-1319

Atlanta, GA  
Boston, MA  
Charlotte, NC  
Cincinnati, OH  
Cleveland, OH  
Dallas, TX  
Denver, CO  
Des Moines, IA  
Detroit, MI  
Ft. Wayne, IN  
Hartford, CT  
Houston, TX  
Indianapolis, IN  
Knoxville, TN  
Long Island, NY  
Los Angeles, CA  
Milwaukee, WI  
Minneapolis, MN  
Nashville, TN  
Philadelphia, PA  
Phoenix, AZ  
Pine Brook, NJ  
Portland, OR  
Rochester, NY  
San Francisco, CA  
Seattle, WA  
St. Louis, MO  
Tampa, FL  
Tulsa, OK

Guelph  
Montreal  
Toronto

Monterrey  
Querétaro

Belo Horizonte  
Campinas  
Caxias do Sul  
Curitiba  
Manaus  
São Paulo

Buenos Aires

The products in this catalog may be controlled based on Japan's "Foreign Exchange and Foreign Trade Law". The export from Japan may be subject to an export license from the government of Japan. Additionally, the products also may be controlled by the export or re-export regulations of the United States government or other countries.

If any customer intends to, or shall, export (or re-export), directly or indirectly, any portion of the products, technology or software relating thereto, it is the responsibility of customer to assure compliance with United States and other export control laws and regulations and if appropriate, to secure any required export licenses or approvals in its own name.

Technical data is subject to change without prior notice. No part of this document may be reproduced in any form. All rights reserved.  
© 2013 FANUC America Corporation



FANUC America Corporation  
www.fanucamerica.com  
888-FANUC-US (888-326-8287)